



*Viabizzuno strada principale della frazione di bizzuno in provincia di ravenna dove tra la casa del popolo e la parrocchia, al n°17, sono nato il ventuno luglio millenovecentocinquantacinque. da qui nasce il nome della fabbrica di produzione fondata nel millenovecentonovantaquattro rappresentata da uno spazio bianco attraversato da due linee. una verticale, rigorosa, essenziale, equilibrata: la luce per la luce; ed una inclinata, irriverente nello spazio, ironica, fuori dagli schemi: la luce per la forma. distinte ma complementari si fondono in un unico nome: Viabizzuno.*

*marionanni*

Viabizzuno is the name of the main road of the small village bizzuno located in the province of ravenna, where I was born on the twenty-first july nineteenfiftyfive at n°17, between the 'casa del popolo' and the local parish church. from here the name of the factory founded in nineteen ninety-four represented by a white space intersected by two lines. one vertical, well balanced, logical, essential: the light for the light. the other one dynamic, irreverent, ironic: the light for the form. separate and yet complementary they cast in the same name: Viabizzuno.

prodotto  
product



schede tecniche  
technical data sheet



curve fotometriche  
photometric curves



modelli 3d per i tuoi render  
3d models for your render



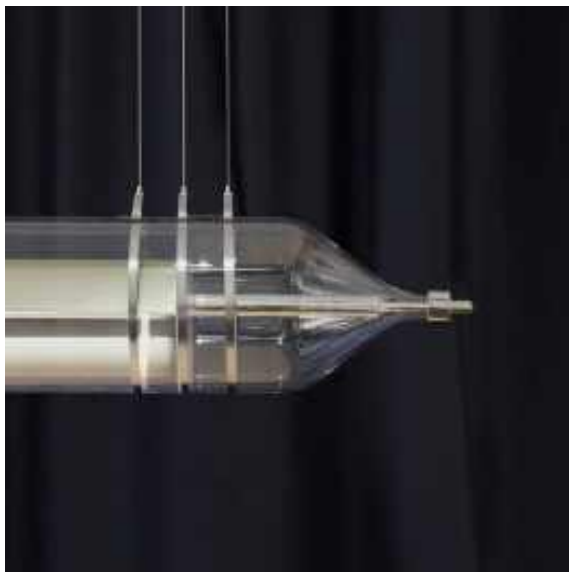

**apparecchio di illuminazione a sospensione per interni IP20.**  
 realizzato in acciaio, alluminio e vetro temprato di spessore 3mm, diametro Ø200mm e lunghezza 2021mm.  
 cablato con doppia sorgente elettronica lineare 2700K o 3000K Ra95 24V fino a 51W e 5081lm, con due accensioni separate.  
 alimentatore in tensione costante escluso da installare remoto.  
 riflettore parabolico con finitura ottone satinato.  
 finitura: vetro trasparente, argento opaco.

**IP20 rated suspension light fitting for indoor use.**  
 made of steel, aluminum and tempered glass, thickness 3mm, diameter Ø200mm and length 2021mm.  
 wired with double linear led source 2700K or 3000K Ra95 24V up to 51W and 5081lm, with double switches.  
 constant voltage power supply not included, to be installed remotely.  
 finishes: transparent glass, matt silver.

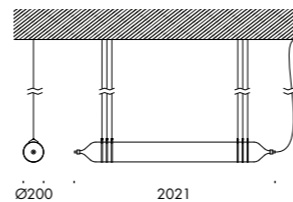

tisoffio 24Vdc IP20

**Vb8.666.01.27** 2700K I1 34W 2021mm 13  
 I2 17W

| Ra    | R9 | ies tm-30 |       | sdc     | V <sub>f</sub> | lm/m                      | W/m | lm/W            |
|-------|----|-----------|-------|---------|----------------|---------------------------|-----|-----------------|
| 95    | 90 | Rf 90     | Rg 98 | step 2  | 24             | 2400                      | 26  | 92              |
| V3000 |    | 11        |       | Ta25 °C |                | vita media · average life |     | 50000 h L80 B10 |

**I2**

| Ra    | R9 | ies tm/30 |        | sdc     | V <sub>f</sub> | lm/m                      | W/m | lm/W            |
|-------|----|-----------|--------|---------|----------------|---------------------------|-----|-----------------|
| 95    | 90 | Rf 93     | Rg 102 | step 2  | 24             | 1200                      | 13  | 92              |
| V0000 |    | 5,9       |        | Ta25 °C |                | vita media · average life |     | 50000 h L80 B10 |

**Vb8.666.01.30** 3000K I1 34W 2021mm 13  
 I2 17W

| Ra    | R9 | ies tm-30 |        | sdc     | V <sub>f</sub> | lm/m                      | W/m | lm/W            |
|-------|----|-----------|--------|---------|----------------|---------------------------|-----|-----------------|
| 95    | 90 | Rf 93     | Rg 102 | step 2  | 24             | 2500                      | 26  | 96              |
| V3001 |    | 11        |        | Ta25 °C |                | vita media · average life |     | 50000 h L80 B10 |

**I2**

| Ra    | R9 | ies tm/30 |        | sdc     | V <sub>f</sub> | lm/m                      | W/m | lm/W            |
|-------|----|-----------|--------|---------|----------------|---------------------------|-----|-----------------|
| 95    | 90 | Rf 93     | Rg 102 | step 2  | 24             | 1250                      | 13  | 96              |
| V0001 |    | 5,9       |        | Ta25 °C |                | vita media · average life |     | 50000 h L80 B10 |

**rosoni di alimentazione. ceiling roses.**

**Vb9.001.84** cromo lucido · polished chrome. 0,3

**Vb9.580.73** cassaforma cartongesso scomparsa totale  
 plasterboard housing total recessed 0,2

**Vb9.580.74** cassaforma laterizio scomparsa totale  
 brick housing total recessed 0,2

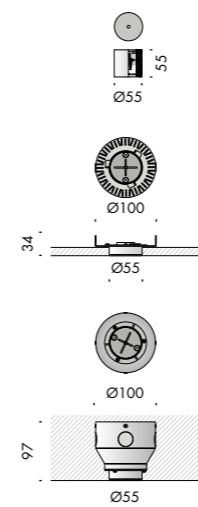

cavo alimentazione 4 poli  
 doppia accensione  
 4 wires cable  
 double switch

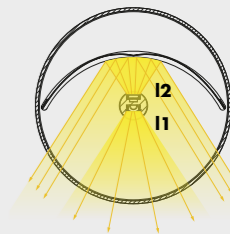

installazione a scomparsa totale  
 completely recessed installation

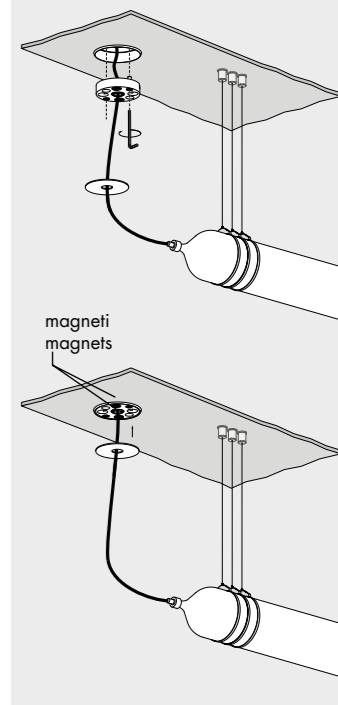





**lettura delle tabelle tecniche how to read technical tables**

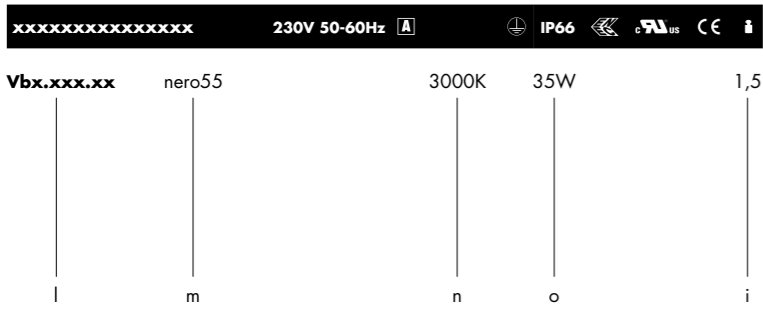
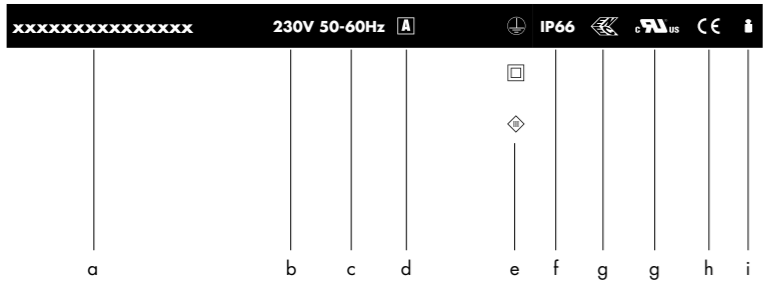

**componenti. components.** IK10 CE i

**accessori. accessories.** IK10 CE i

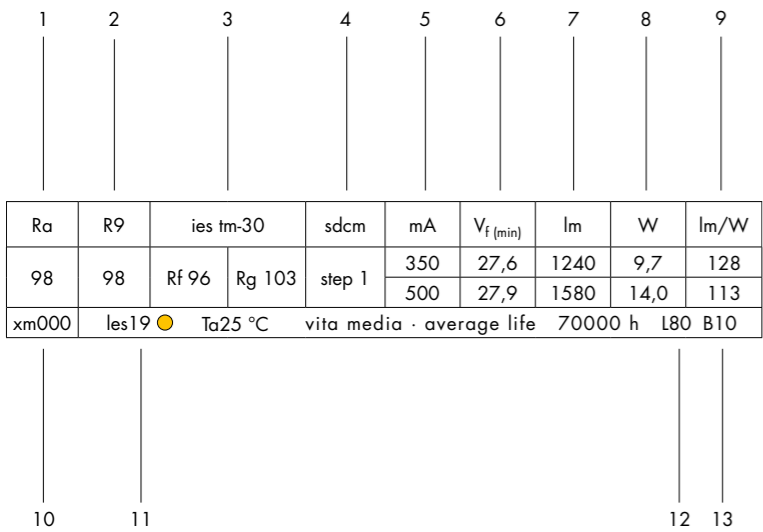

bandella tecnica. posizioni standard simbologie.  
data plate. standard arrangement of symbols.

|   |   |
|---|---|
| a | nome apparecchio di illuminazione · light fitting name                            |
| b | tensione di alimentazione · supply rating (Volt)                                  |
| c | frequenza di alimentazione · supply frequency (Hertz)                             |
| d | alimentatore incluso o escluso · power supply included or not included            |
| e | classe di isolamento · insulation class   |
| f | grado di protezione · protection degree   |
| g | marchio di certificazione · safety and quality standards certification            |
| h | conforme alle direttive europee<br>produced in compliance with EC directives      |
| i | peso netto · net weight (kg)  |
| l | codice · code   |
| m | finitura · finish   |
| n | temperatura colore sorgente elettronica<br>colour temperature led source (Kelvin) |
| o | potenza della sorgente · source power (Watt)                                      |

componenti. identifica tutti gli elementi indispensabili per la corretta funzionalità e installazione dell'apparecchio di illuminazione.  
components. includes all items that are essential to the correct operation and installation of the light fitting.

accessori. si riferisce alle ulteriori parti installabili sull'apparecchio.  
accessories. refers to items that can be added to the light fitting.

|    |  |
|----|--|
| 1  | indice di resa cromatica · colour rendering index  |
| 2  | indice di resa del rosso · red colour rendering index  |
| 3  | Rf indice di fedeltà colore · colour fidelity index<br>Rg indice di saturazione colore · color gamut index |
| 4  | step di macadam · macadam step   |
| 5  | corrente di alimentazione · power supply current   |
| 6  | tensione di alimentazione · power supply voltage   |
| 7  | flusso luminoso · light flux   |
| 8  | potenza della sorgente · source power  |
| 9  | efficienza della sorgente · source efficiency  |
| 10 | codice sorgente elettronica Viabizzuno · Viabizzuno led source code  |
| 11 | superficie emittente · light emitting surface (mm)   |
| 12 | % flusso residuo a fine vita · end life % flux   |
| 13 | % consentita sotto limite · allowed % under limit  |

**gradi di protezione protection degrees**

|       |  |      |  |
|-------|--|------|--|
| IPX0  | non protetto<br>no protection  | IK01 | nessuna protezione<br>no protection  |
| IPX1  | protetto contro la caduta verticale di gocce d'acqua<br>protected against water drops falling vertically         | IK01 | protetto contro l'energia d'urto 0,15J<br>protected against collision energy |
| IPX2  | protetto contro la caduta di gocce con inclinazione max 15°<br>protected against water drops max inclination 15° | IK02 | protetto contro l'energia d'urto 0,2J<br>protected against collision energy  |
| IPX3  | protetto contro la caduta di gocce con inclinazione max 60°<br>protected against water drops max inclination 60° | IK03 | protetto contro l'energia d'urto 0,35J<br>protected against collision energy |
| IPX4  | protetto contro spruzzi d'acqua<br>protected against sprinkling water  | IK04 | protetto contro l'energia d'urto 0,5J<br>protected against collision energy  |
| IPX5  | protetto contro getti d'acqua<br>protected against water jets  | IK05 | protetto contro l'energia d'urto 0,7J<br>protected against collision energy  |
| IPX6  | protetto contro inondazioni<br>protected against flooding  | IK06 | protetto contro l'energia d'urto 1J<br>protected against collision energy    |
| IPX7  | per breve immersione<br>protected against brief immersions   | IK07 | protetto contro l'energia d'urto 2J<br>protected against collision energy    |
| IPX8  | per immersione prolungata<br>protected against long immersion  | IK08 | protetto contro l'energia d'urto 5J<br>protected against collision energy    |
| IPX9  | per immersione prolungata<br>protected against long immersion  | IK09 | protetto contro l'energia d'urto 10J<br>protected against collision energy   |
| IPX10 | per immersione prolungata<br>protected against long immersion  | IK10 | protetto contro l'energia d'urto 20J<br>protected against collision energy   |

|      |   |
|------|---|
| IPOX | non protetto<br>no protection                                     |
| IP1X | contro corpi estranei >50 mm<br>protection against solid objects  |
| IP2X | contro corpi estranei >12 mm<br>protection against solid objects  |
| IP3X | contro corpi estranei >2,5 mm<br>protection against solid objects |
| IP4X | contro corpi estranei >1 mm<br>protection against solid objects   |
| IP5X | protezione da polvere<br>dust-protected                           |
| IP6X | stagno alla polvere<br>dust-proof                                 |

## legenda simboli symbols key

|   |  |
|---|--|
| <b>ta</b>   | <i>tavolo</i> · table  |
| <b>tr</b>   | <i>terra</i> · floor standing  |
| <b>s</b>  | <i>soffitto</i> · ceiling  |
| <b>p</b>  | <i>parete</i> · wall   |
| <b>sp</b>   | <i>sospensione</i> · suspension  |
| <b>bin</b>  | <i>binario</i> · track   |
| <b>in</b>   | <i>incasso</i> · recessed  |
| <b>st</b>   | <i>scomparsa totale</i> · fully concealed  |
| <b>s+e</b>  | <i>segnaletica+emergenza</i> · signalling system+emergency   |
| <b>bat</b>  | <i>portatili autoalimentati a batteria</i> · portable self-powered with battery  |
| <b>sis</b>  | <i>sistemi</i> · systems   |
| <b>pa</b>   | <i>palo</i> · pole   |
| <b>pt</b>   | <i>paletto</i> · bollard   |
| <b>sd</b>   | <i>seduta</i> · sitting  |
| <b>V</b>  | <i>disponibile su</i> · available on <i>Viabizzuno applight</i> <i>www.Viabizzuno.com</i> <i>Viabizzuno online</i>   |
|    | <i>classe I. solo isolamento fondamentale, le parti conduttrici accessibili sono collegate ad un conduttore di terra. messa a terra tassativa</i><br>class I. only basic insulation, accessible conductors are earthed. earthing compulsory  |
|   | <i>classe II. all'isolamento principale è aggiunto un secondo isolamento oppure ai due isolamenti è sostituito un isolamento rinforzato. messa a terra esclusa</i><br>class II. basic insulation plus second insulation or both are replaced by reinforced insulation. earthing excluded |
|  | <i>classe III. alimentazione effettuata con bassissima tensione di sicurezza; sono escluse tensioni superiori a 50V-50Hz. messa a terra non prevista.</i><br>class III. very low safety supply tension; not to be used over 50V-50Hz. earthing excluded.                                 |
|  | <i>prodotto conforme alle direttive europee</i> · produced in compliance with ec directives  |
|  | <i>marchio di certificazione europea. certifica che il prodotto è conforme alle norme europee sulla sicurezza</i><br>component approved for north american market and suitable to be used and approved as part of a more complex system  |
|  | <i>componente certificato per il mercato nord americano idoneo ad essere utilizzato e valutato come parte di in un sistema più complesso</i><br>component approved for north american market and suitable to be used and approved as part of a more complex system                       |
|  | <i>apparecchio di illuminazione approvato da kema</i> · kema approved light fitting  |
|  | <i>prodotto conforme agli standard presenti nel regno unito che regolamentano la sicurezza e la qualità dell'acqua</i> · product complies with uk standards set out by water regulations   |
|  | <i>apparecchio di illuminazione certificato secondo le normative vigenti in polonia che regolamentano i dispositivi di sicurezza antincendio</i><br>certified light fitting according to the regulations about devices for fire safety in force in poland                                |
|  | <i>prodotto idoneo per essere commercializzato nel mercato cinese</i> · product suitable for the china market  |
|  | <i>prodotto finito idoneo per essere commercializzato nel mercato nord americano</i> · listed product suitable for the north american market   |
|  | <i>prodotto conforme alla legislazione vigente nel regno unito</i> · produced in compliance with UK legislation  |
|  | <i>apparecchio di illuminazione certificato per il mercato cinese</i><br>light fitting certified for china market  |

|   |   |
|---|---|
|    | <i>vetro opalino</i> · opal glass   |
|    | <i>vetro sabbiato</i> · sanded glass  |
|    | <i>vetro nero fumè</i> · black smoke glass  |
|    | <i>vetro trasparente</i> · transparent glass  |
|    | <i>vetro bianco latte</i> · white milk glass  |
|    | <i>crystallo</i> · crystal  |
|    | <i>policarbonato opalino</i> · opal polycarbonate diffuser  |
|    | <i>carrabile</i> · drive over   |
|    | <i>alimentatore incluso</i> · power supply included   |
|    | <i>alimentatore escluso</i> · power supply not included   |
|    | <i>alimentatore remoto incluso</i> · remote power supply included   |
|    | <i>alimentatore elettronico con controllo intelligente incluso</i> · electronic power supply with smart control included  |
|    | <i>alimentatore elettronico con controllo intelligente incluso, da installare remoto</i> · electronic power supply with smart control included, to be installed remotely  |
|    | <i>alimentatore a spina incluso</i> · plug power supply included  |
|    | <i>trasformatore incluso</i> · transformer included   |
|    | <i>trasformatore escluso</i> · transformer not included   |
|    | <i>kit di cablaggio</i> · wiring kit  |
|   | <i>kit di cablaggio escluso</i> · wiring kit not included   |
|  | <i>lampadina con sorgente elettronica led, ad incandescenza, alogena o fluorescente inclusa.</i><br>bulb with led electronic source, incandescent, halogen or fluorescent included.                               |
|  | <i>lampadina con sorgente elettronica led, ad incandescenza, alogena o fluorescente esclusa.</i><br>bulb with led electronic source, incandescent, halogen or fluorescent not included.                           |
|  | <i>propulsore dinamico n55 incluso</i> · included   |
|  | <i>possibilità di combinazione tra interfaccia n55, propulsore dinamico n55 e lampadina n55</i> · possible combination between n55 interface, propulsore dinamico n55 and n55 bulb                                |
|  | <i>attenzione: sorgente luminosa led. non guardare mai direttamente a occhio nudo</i> · attention: led light source. never look straight without eye protection   |
|  | <i>flicker free compatibile con fotocamere digitali</i> · flicker free digital camera friendly  |
| <b>l.d.</b>   | <i>luce diretta</i> · direct light  |
| <b>l.i.</b>   | <i>luce indiretta</i> · indirect light  |
| <b>.d1</b>  | <i>dimmerazione 1-10V</i> · 1-10V dimmable  |
| <b>.d2</b>  | <i>dimmerazione dali</i> · dimmable dali  |
| <b>.SA</b>  | <i>kit luce + emergenza sempre accese. attenzione: non è possibile installare nelle cassaforme laterizio</i><br>light kit + permanently lit emergency lamp. please note: cannot be installed in brickwork housing |
| <b>.SE</b>  | <i>solo emergenza sempre accesa. attenzione: non è possibile installare nelle cassaforme laterizio</i><br>permanently lit emergency lamp only. please note: cannot be installed in brickwork housing              |
|  | <i>peso netto</i> · net weight (kg)   |